

STARFINDER

PAWN COLLECTION

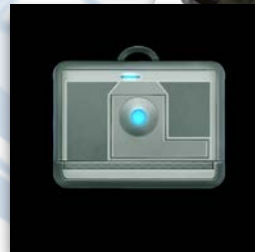

TECH TERRAIN

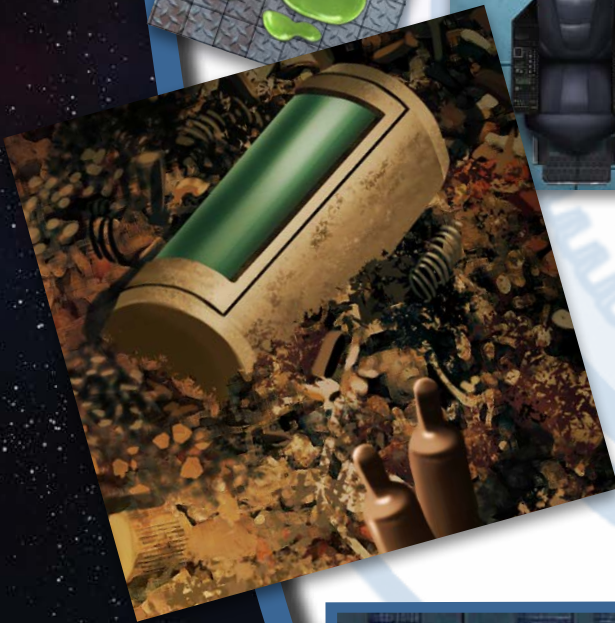
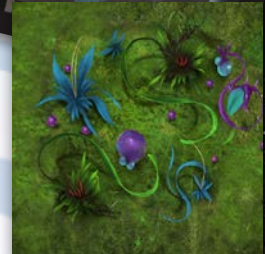
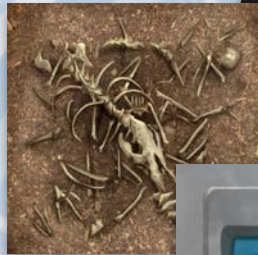
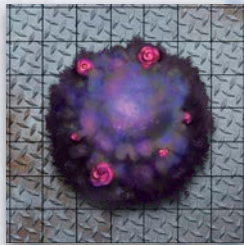

ARCANE LABORATORY
© 2019 PAIZO INC.

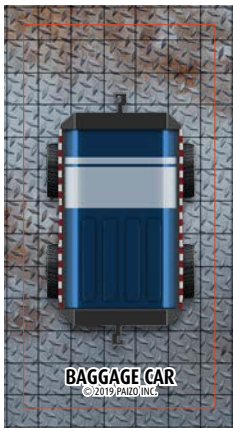

BAGGAGE CAR
© 2019 PAIZO INC.

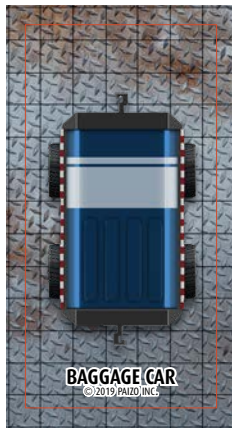

BAGGAGE CAR
© 2019 PAIZO INC.



BAGGAGE TRUCK
© 2019 PAIZO INC.

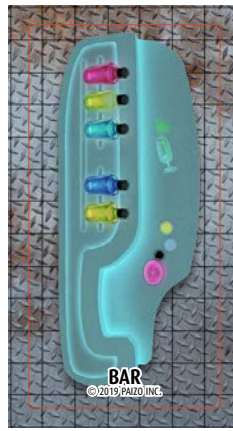

BAR
© 2019 PAIZO INC.

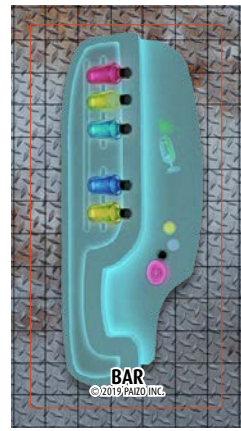

BAR
© 2019 PAIZO INC.



BARBED WIRE
© 2019 PAIZO INC.



BARBED WIRE
© 2019 PAIZO INC.



BARBED WIRE
© 2019 PAIZO INC.



BARBED WIRE
© 2019 PAIZO INC.



BENCH
© 2019 PAIZO INC.



BENCH
© 2019 PAIZO INC.



BUNK
© 2019 PAIZO INC.



BUNK
© 2019 PAIZO INC.



BUNK
© 2019 PAIZO INC.



BUNK
© 2019 PAIZO INC.



BUNK
© 2019 PAIZO INC.



BUNK
© 2019 PAIZO INC.



CATWALK
© 2019 PAIZO INC.



CATWALK
© 2019 PAIZO INC.



CATWALK
© 2019 PAIZO INC.



CATWALK
© 2019 PAIZO INC.

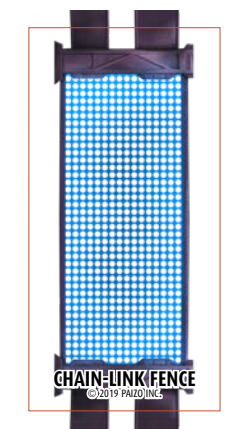

CHAIN-LINK FENCE
© 2019 PAIZO INC.

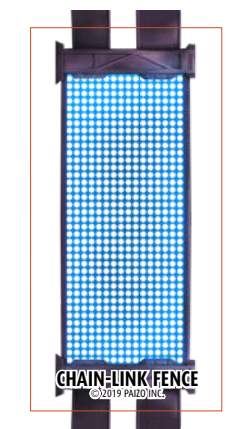

CHAIN-LINK FENCE
© 2019 PAIZO INC.



ALIEN BONES
© 2019 PAIZO INC.



ALIEN BONES
© 2019 PAIZO INC.



ALIEN EGGS
© 2019 PAIZO INC.



ALIEN EGGS
© 2019 PAIZO INC.



ALIEN FUNGUS
© 2019 PAIZO INC.

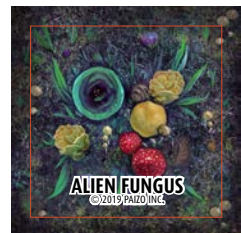

ALIEN FUNGUS
© 2019 PAIZO INC.

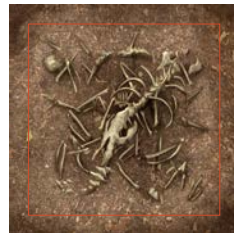
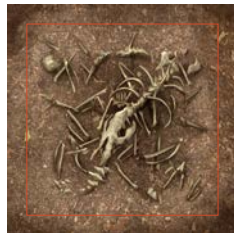
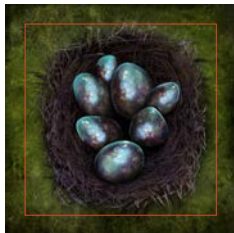
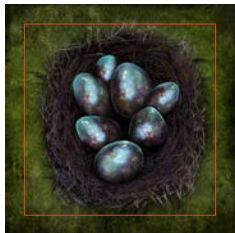
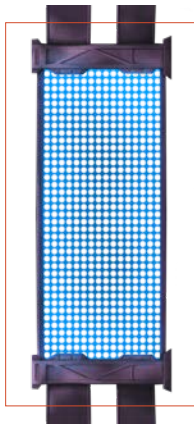
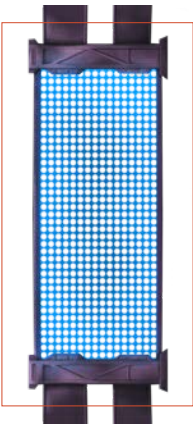
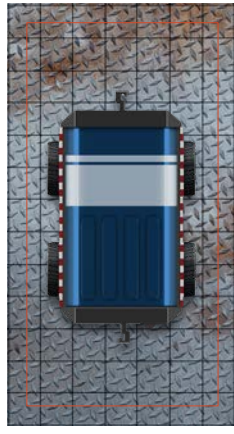
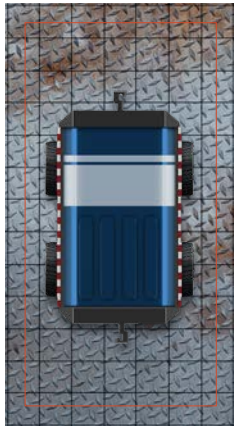

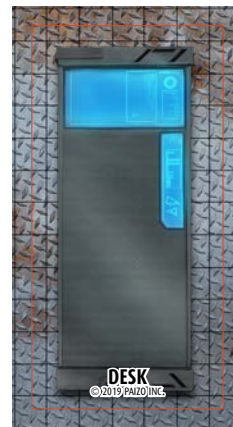
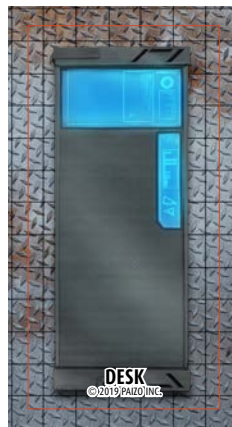
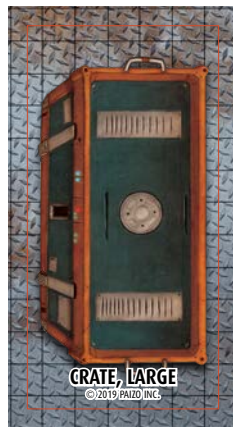
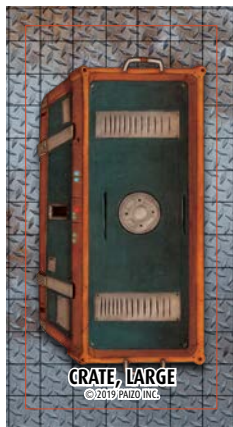
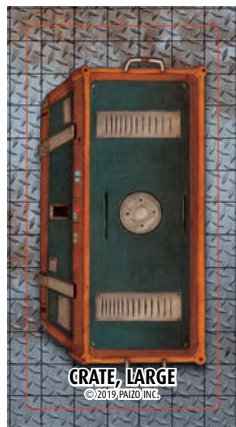
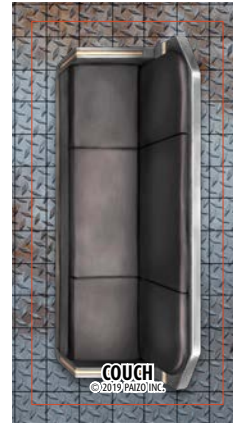
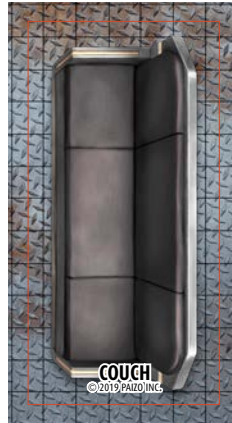
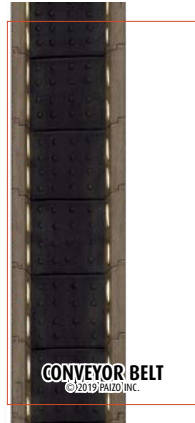
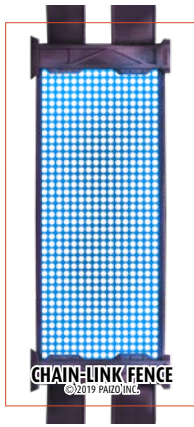
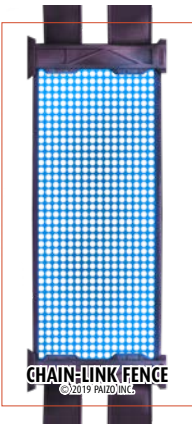

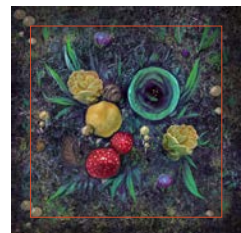
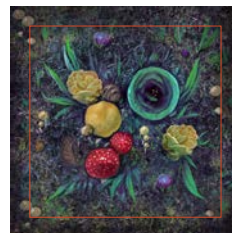
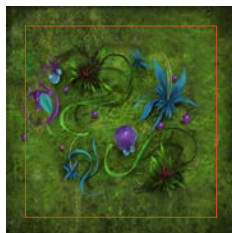
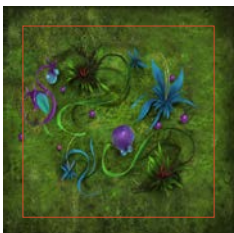
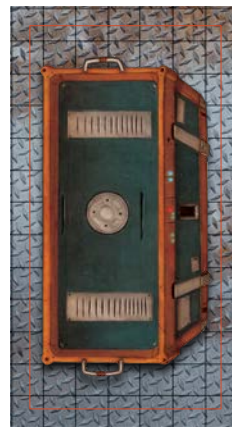
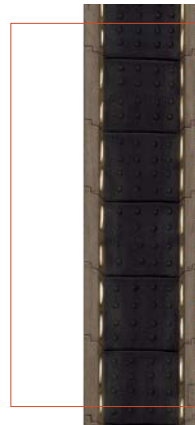
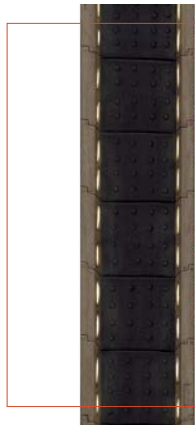
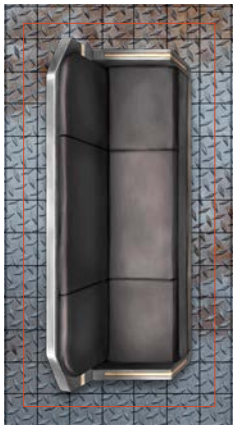
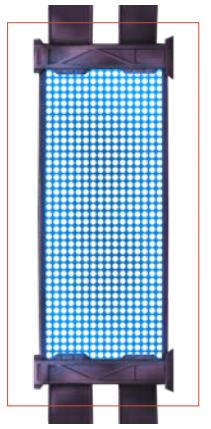
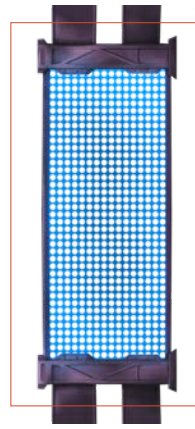

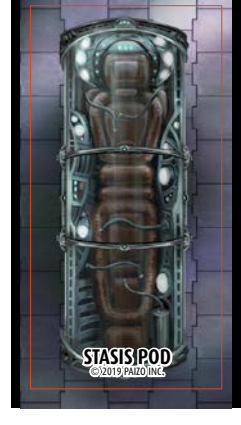
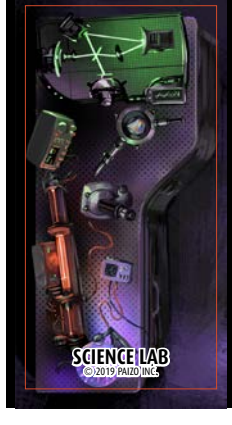
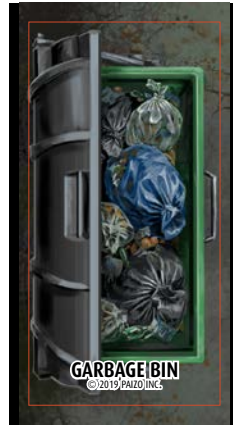
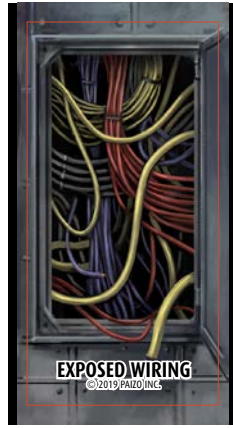
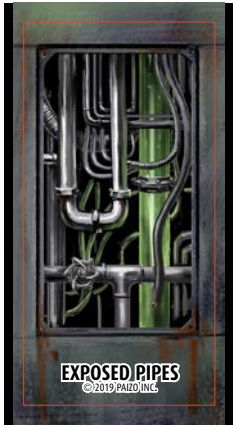
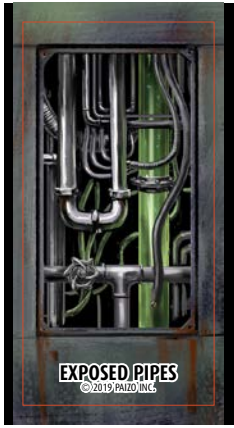
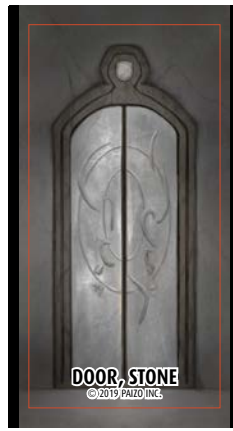
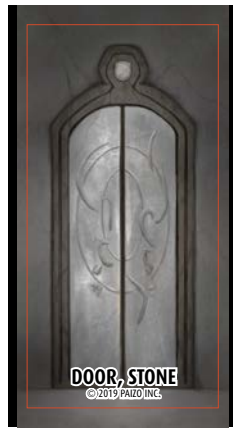
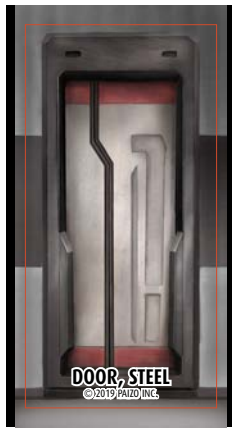
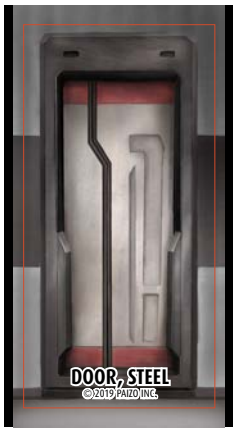

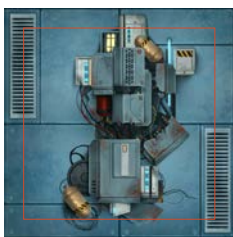
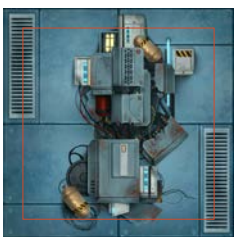
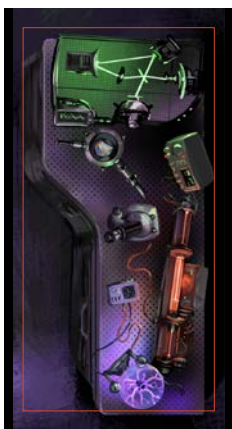
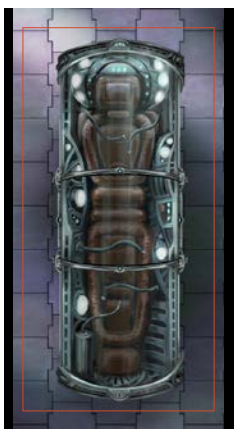
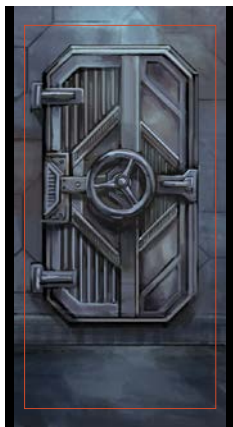
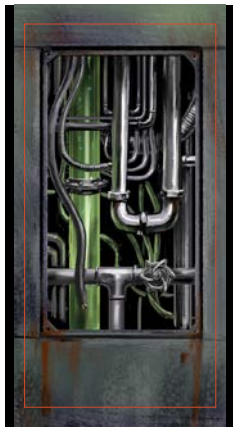
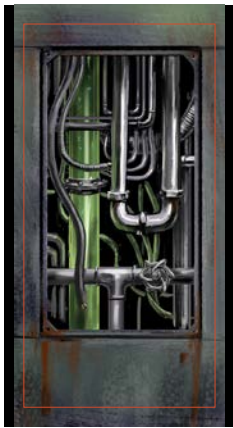
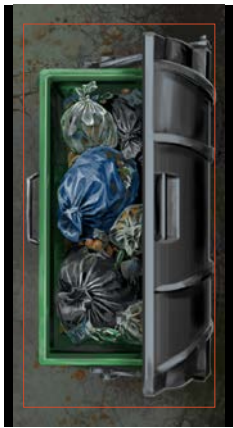
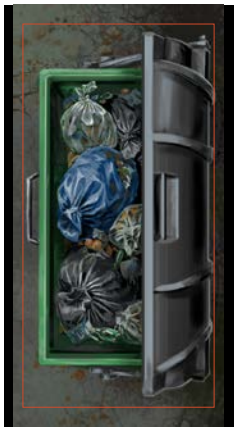

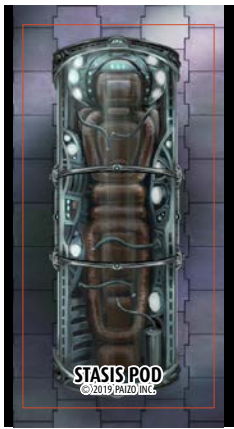

STASISPOD
© 2019 PAIZO INC.

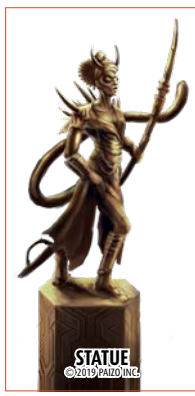

STATUE
© 2019 PAIZO INC.

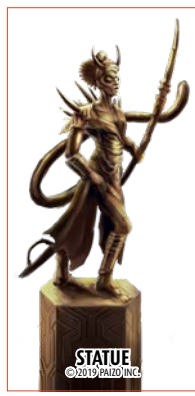

STATUE
© 2019 PAIZO INC.



STATUE, HOLO
© 2019 PAIZO INC.



STATUE, HOLO
© 2019 PAIZO INC.

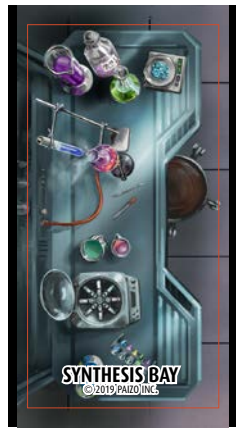

SYNTHESIS BAY
© 2019 PAIZO INC.



TECHWORKSHOP
© 2019 PAIZO INC.

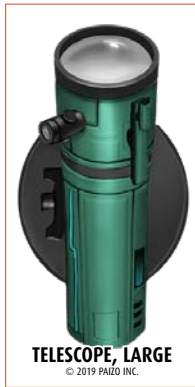

TELESCOPE, LARGE
© 2019 PAIZO INC.



TOILET CUBICLE
© 2019 PAIZO INC.



TOILET CUBICLE
© 2019 PAIZO INC.



TREE TRUNK
© 2019 PAIZO INC.



TREE TRUNK
© 2019 PAIZO INC.



TREE TRUNK
© 2019 PAIZO INC.



TREE TRUNK
© 2019 PAIZO INC.



VENDING MACHINE
© 2019 PAIZO INC.



VENDING MACHINE
© 2019 PAIZO INC.



VIDEO GAME
© 2019 PAIZO INC.



VIDEO GAME
© 2019 PAIZO INC.



BLOOD SPATTER
© 2019 PAIZO INC.



BLOOD SPATTER
© 2019 PAIZO INC.

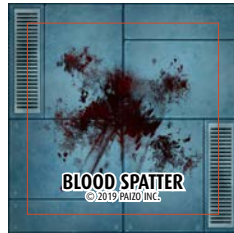

BLOOD SPATTER
© 2019 PAIZO INC.



BLOOD SPATTER
© 2019 PAIZO INC.

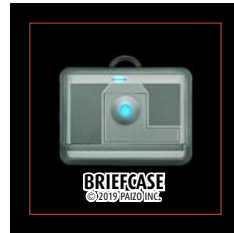

BRIEFCASE
© 2019 PAIZO INC.



BRIEFCASE
© 2019 PAIZO INC.

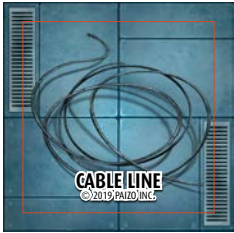

CABLE LINE
© 2019 PAIZO INC.

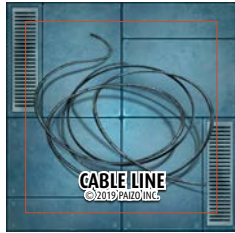

CABLE LINE
© 2019 PAIZO INC.



CAFE TABLE
© 2019 PAIZO INC.



CAFE TABLE
© 2019 PAIZO INC.

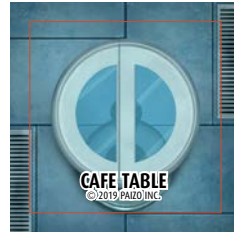

CAFE TABLE
© 2019 PAIZO INC.



CAFE TABLE
© 2019 PAIZO INC.

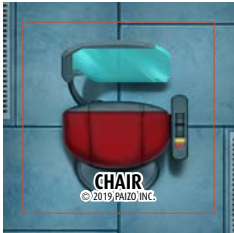

CHAIR
© 2019 PAIZO INC.



CHAIR
© 2019 PAIZO INC.



CHAIR
© 2019 PAIZO INC.



CHAIR
© 2019 PAIZO INC.



CHAIR, STARSHIP
© 2019 PAIZO INC.



CHAIR, STARSHIP
© 2019 PAIZO INC.

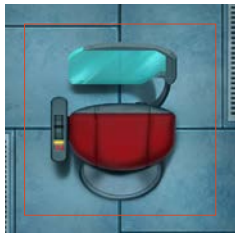
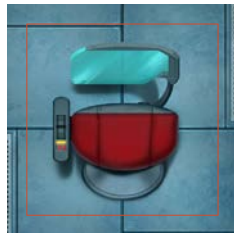
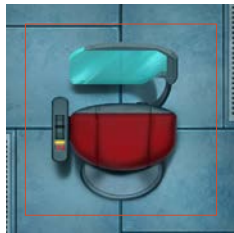
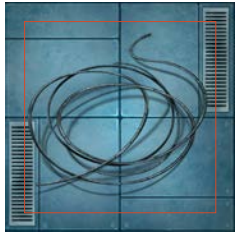
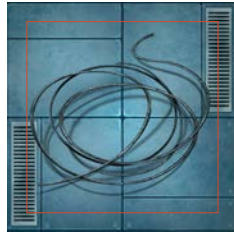
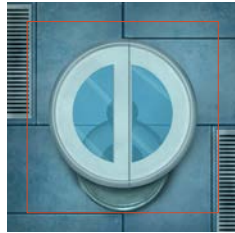
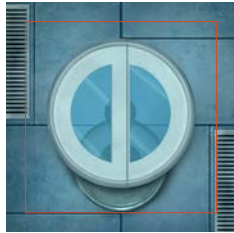
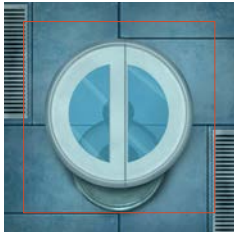
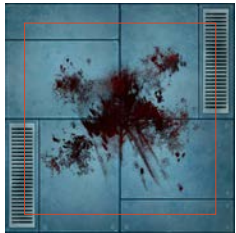
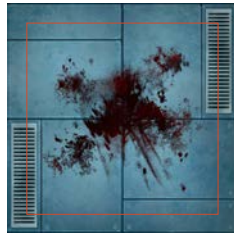
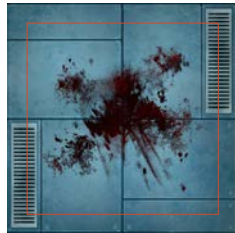
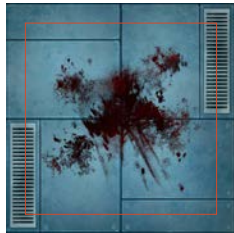
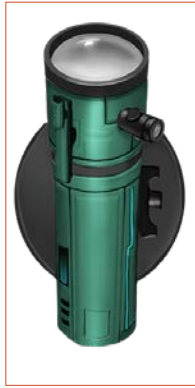
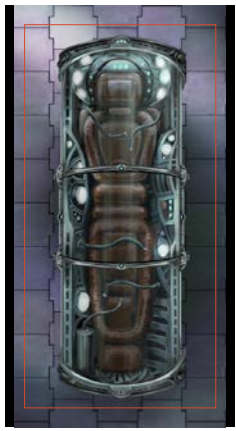
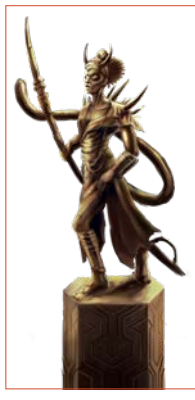
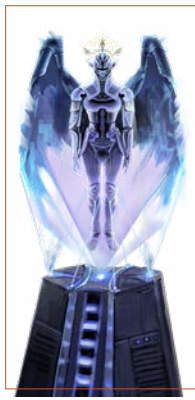
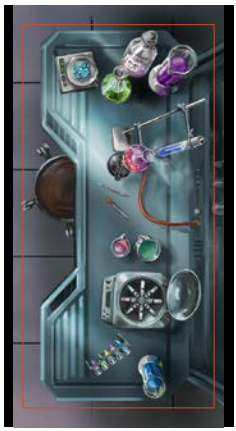

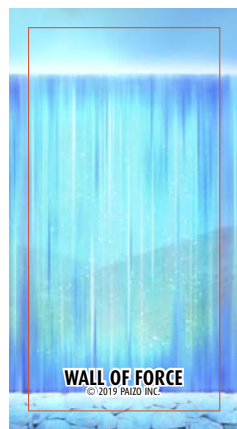
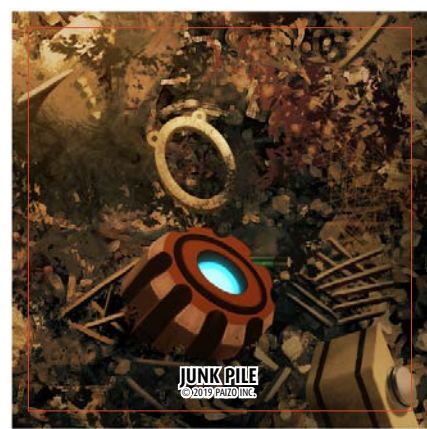
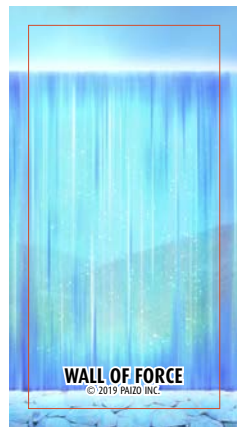
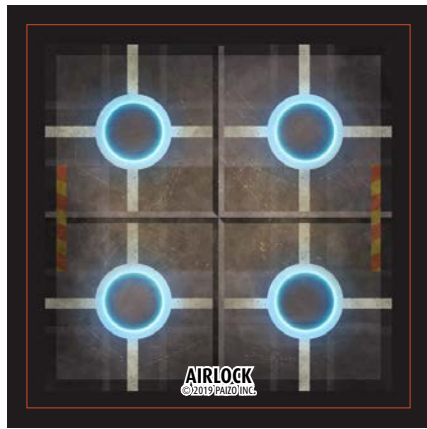

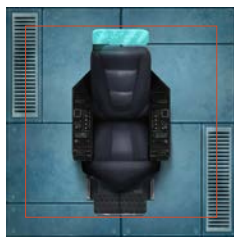
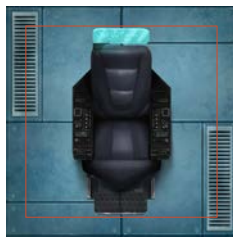
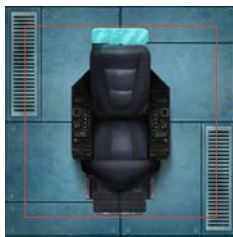
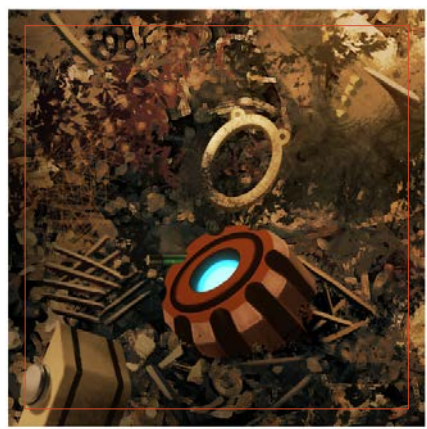
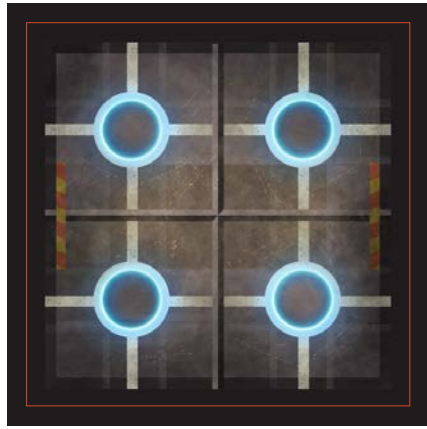



FOUNTAIN
© 2019 PAIZO INC.



GREASE
© 2019 PAIZO INC.

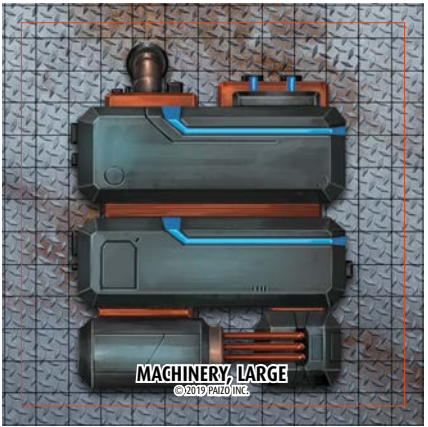

MACHINERY, LARGE
© 2019 PAIZO INC.



WALL OF STEEL
© 2019 PAIZO INC.

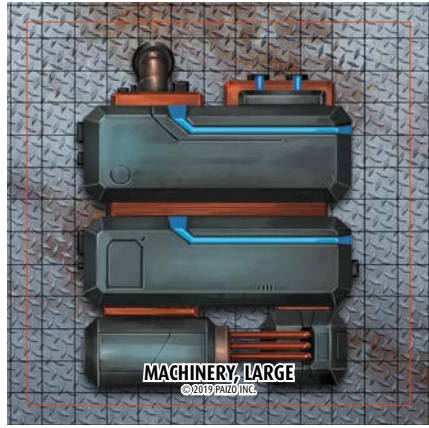

MACHINERY, LARGE
© 2019 PAIZO INC.



POWER CORE
© 2019 PAIZO INC.



SATELLITE DISH
© 2019 PAIZO INC.



WALL OF STEEL
© 2019 PAIZO INC.



SCULPTURE
© 2019 PAIZO INC.

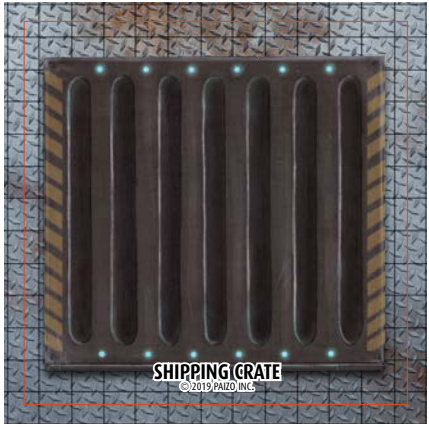

SHIPPING CRATE
© 2019 PAIZO INC.

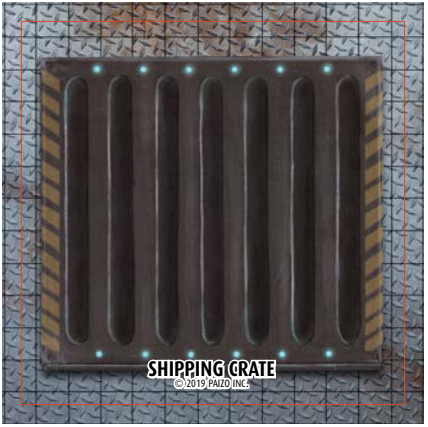

SHIPPING CRATE
© 2019 PAIZO INC.

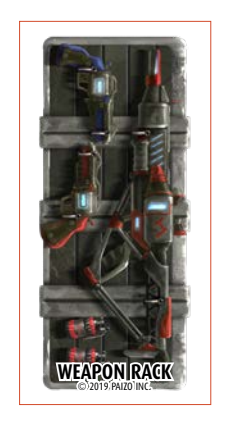

WEAPON RACK
© 2019 PAIZO INC.



TENT, MASS PRODUCED
© 2019 PAIZO INC.



TENT, MASS PRODUCED
© 2019 PAIZO INC.

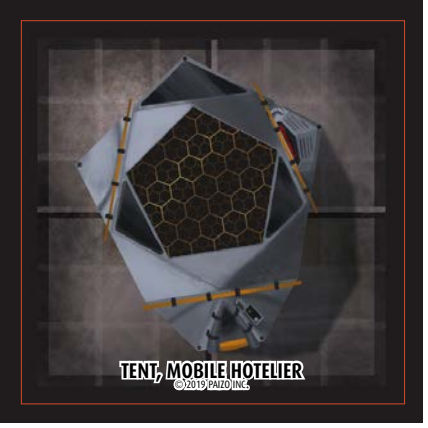

TENT, MOBILE HOTELIER
© 2019 PAIZO INC.

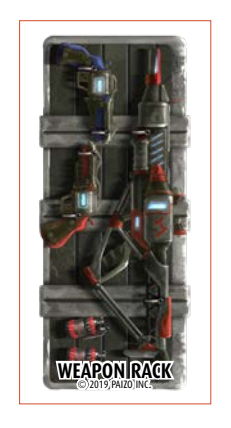

WEAPON RACK
© 2019 PAIZO INC.



COMPUTER CONSOLE, SMALL
© 2019 PAIZO INC.



COMPUTER CONSOLE, SMALL
© 2019 PAIZO INC.



CONVEYOR BELT, CURVED
© 2019 PAIZO INC.



CONVEYOR BELT, CURVED
© 2019 PAIZO INC.



CONVEYOR BELT, CURVED
© 2019 PAIZO INC.



CONVEYOR BELT, CURVED
© 2019 PAIZO INC.

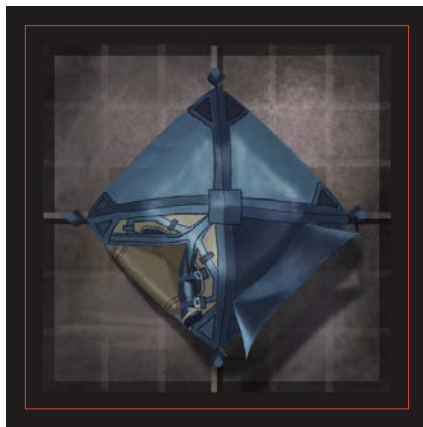
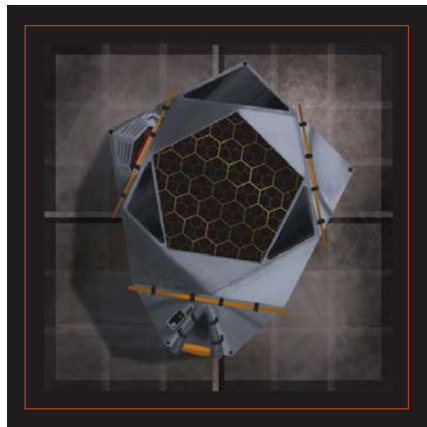
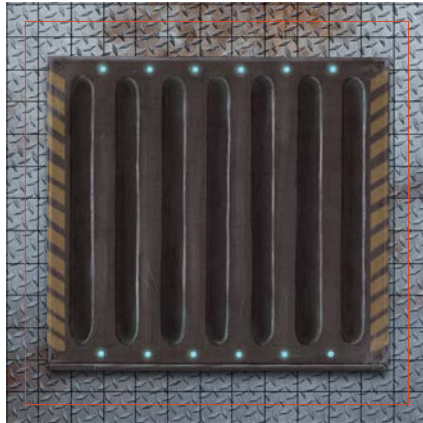
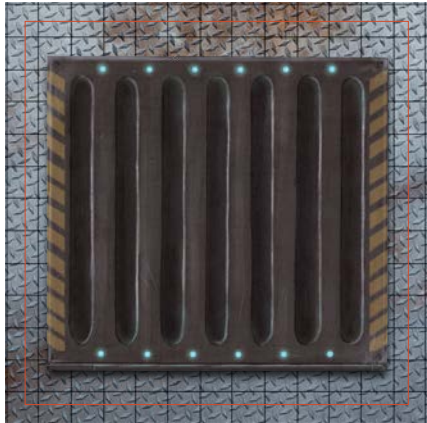
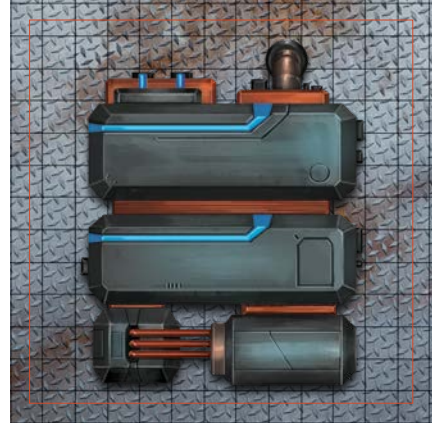
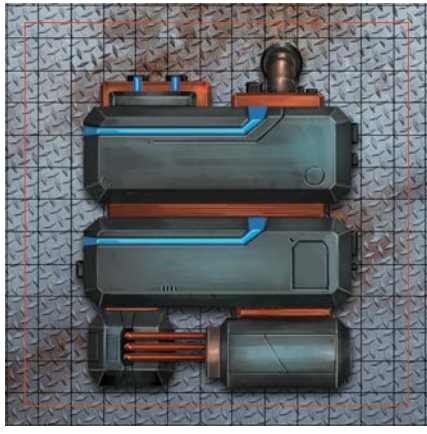

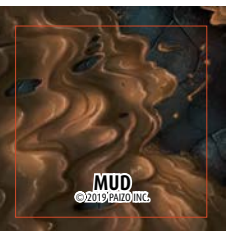
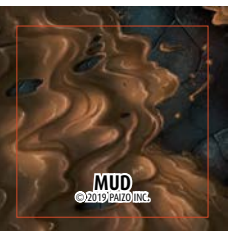
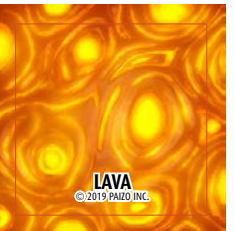
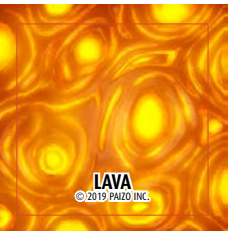
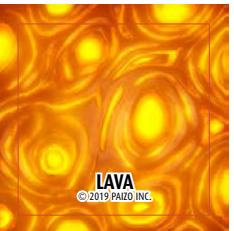
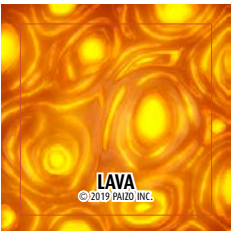
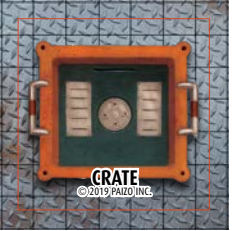
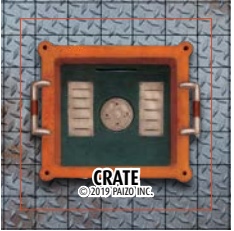



MUD
© 2019 PAIZO INC.



MUD
© 2019 PAIZO INC.



POTTED PLANT
© 2019 PAIZO INC.



POTTED PLANT
© 2019 PAIZO INC.



POTTED PLANT
© 2019 PAIZO INC.



POTTED PLANT
© 2019 PAIZO INC.



RUBBLE
© 2019 PAIZO INC.

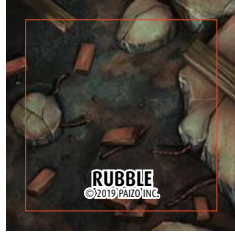

RUBBLE
© 2019 PAIZO INC.

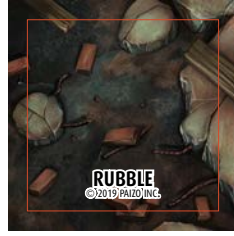

RUBBLE
© 2019 PAIZO INC.



RUBBLE
© 2019 PAIZO INC.



RUNE
© 2019 PAIZO INC.



RUNE
© 2019 PAIZO INC.



SECURITY CAMERA
© 2019 PAIZO INC.



SECURITY CAMERA
© 2019 PAIZO INC.



SECURITY CAMERA
© 2019 PAIZO INC.



SENTRY GUN
© 2019 PAIZO INC.



SENTRY GUN
© 2019 PAIZO INC.



SENTRY GUN
© 2019 PAIZO INC.



SHRUB
© 2019 PAIZO INC.



SHRUB
© 2019 PAIZO INC.



SHRUB
© 2019 PAIZO INC.



SHRUB
© 2019 PAIZO INC.



SKELETON, HUMANOID
© 2019 PAIZO INC.



SKELETON, HUMANOID
© 2019 PAIZO INC.



SKELETON, ALIEN
© 2019 PAIZO INC.



SKELETON, ALIEN
© 2019 PAIZO INC.



SMOKE/FOG
© 2019 PAIZO INC.



SMOKE/FOG
© 2019 PAIZO INC.



SMOKE/FOG
© 2019 PAIZO INC.



SMOKE/FOG
© 2019 PAIZO INC.



SPACE SUIT
© 2019 PAIZO INC.



SPACE SUIT
© 2019 PAIZO INC.



SPACE SUIT
© 2019 PAIZO INC.



SPACE SUIT
© 2019 PAIZO INC.



TELESCOPE, SMALL
© 2019 PAIZO INC.



TELESCOPE, SMALL
© 2019 PAIZO INC.



TRASH CAN
© 2019 PAIZO INC.



TRASH CAN
© 2019 PAIZO INC.



TRASH CAN
© 2019 PAIZO INC.



TRASH CAN
© 2019 PAIZO INC.



TREE STUMP
© 2019 PAIZO INC.



TREE STUMP
© 2019 PAIZO INC.



TREE STUMP
© 2019 PAIZO INC.



TREE STUMP
© 2019 PAIZO INC.



VENT
© 2019 PAIZO INC.



VENT
© 2019 PAIZO INC.



VENT
© 2019 PAIZO INC.



VENT
© 2019 PAIZO INC.

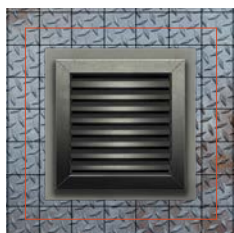
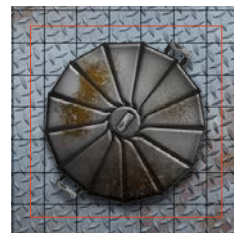
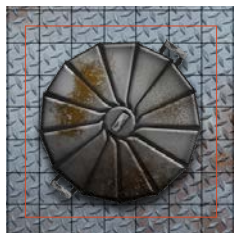
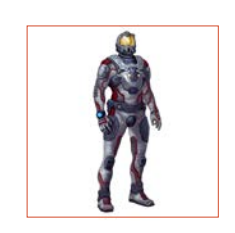
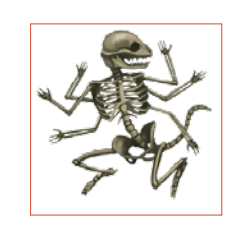
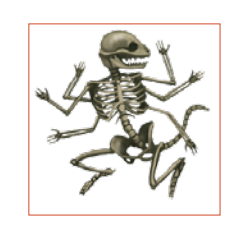
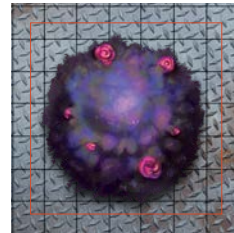
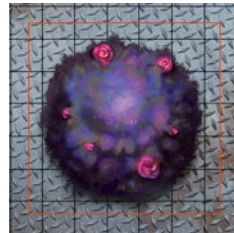
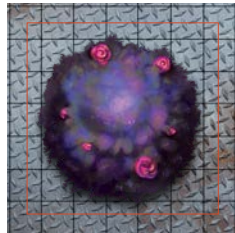
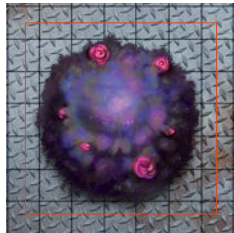
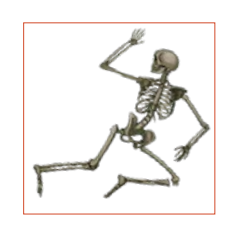
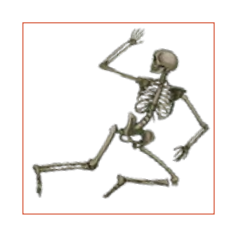
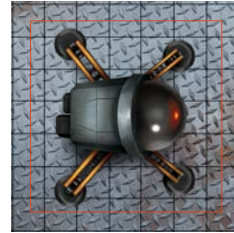
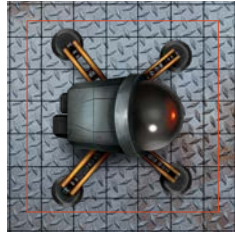
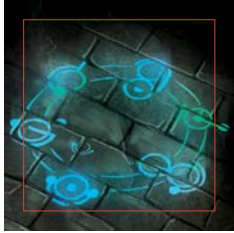
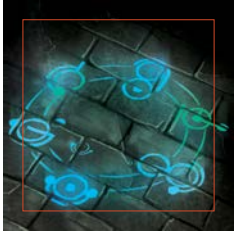
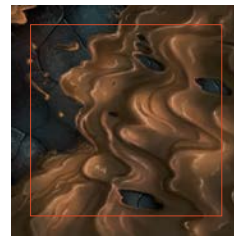
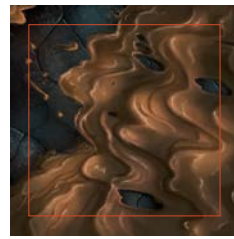

Pawn Artists: Enrique Barajas, Leonardo Borazio, Hannah Böving, Sergio Cosmai, Tawny Fritz, Sebastian Gomez, Dion Harris, Marko Horvatin, Josef Kučera, Sebastian Rodriguez, Tadas Sidlauskas, Tom Ventre, Benjamin Widdowson

Product Identity: The following items are hereby identified as Product Identity, as defined in the Open Game License version 1.0a, Section 1(e), and are not Open Game Content: All trademarks, registered trademarks, proper nouns (characters, deities, locations, etc., as well as all adjectives, names, titles, and descriptive terms derived from proper nouns), artworks, characters, dialogue, locations, plots, storylines, and trade dress. (Elements that have previously been designated as Open Game Content, or are exclusively derived from previous Open Game Content, or that are in the public domain are not included in this declaration.)

Open Game Content: Except for material designated as Product Identity (see above), the game mechanics of this Paizo game product are Open Game Content, as defined in the Open Game License, version 1.0a, Section 1(d). No portion of this work other than the material designated as Open Game Content may be reproduced in any form without written permission.

OPEN GAME LICENSE VERSION 1.0A

The following text is the property of Wizards of the Coast, Inc. and is Copyright 2000 Wizards of the Coast, Inc. ("Wizards"). All Rights Reserved.

1. Definitions: (a) "Contributors" means the copyright and/or trademark owners who have contributed Open Game Content; (b) "Derivative Material" means copyrighted material including derivative works and translations (including into other computer languages), potation, modification, correction, addition, extension, upgrade, improvement, compilation, abridgment or other form in which an existing work may be recast, transformed or adapted; (c) "Distribute" means to reproduce, license, rent, lease, sell, broadcast, publicly display, transmit or otherwise distribute; (d) "Open Game Content" means the game mechanic and includes the methods, procedures, processes and routines to the extent such content does not embody the Product Identity and is an enhancement over the prior art and any additional content clearly identified as Open Game Content by the Contributor, and means any work covered by this License, including translations and derivative works under copyright law, but specifically excludes Product Identity. (e) "Product Identity" means product and product line names, logos and identifying marks including trade dress; artifacts, creatures, characters, stories, storylines, plots, thematic elements, dialogue, incidents, language, artwork, symbols, designs, depictions, likenesses, formats, poses, concepts, themes and graphic, photographic and other visual or audio representations; names and descriptions of characters, spells, enchantments, personalities, teams, personas, likenesses and special abilities; places, locations, environments, creatures, equipment, magical or supernatural abilities or effects, logos, symbols, or graphic designs; and any other trademark or registered trademark clearly identified as Product identity by the owner of the Product Identity, and which specifically excludes the Open Game Content; (f) "Trademark" means the logos, names, mark, sign, motto, designs that are used by a Contributor to identify itself or its products or the associated products contributed to the Open Game License by the Contributor (g) "Use", "Used" or "Using" means to use, Distribute, copy, edit, format, modify, translate and otherwise create Derivative Material of Open Game Content. (h) "You" or "Your" means the licensee in terms of this agreement.

2. The License: This License applies to any Open Game Content that contains a notice indicating that the Open Game Content may only be Used under and in terms of this License. You must affix such a notice to any Open Game Content that you Use. No terms may be added to or subtracted from this License except as described by the License itself. No other terms or conditions may be applied to any Open Game Content distributed using this License.

3. Offer and Acceptance: By Using the Open Game Content You indicate Your acceptance of the terms of this License.

4. Grant and Consideration: In consideration for agreeing to use this License, the Contributors grant You a perpetual, worldwide, royalty-free, non-exclusive license with the exact terms of this License to Use, the Open Game Content.

5. Representation of Authority to Contribute: If You are contributing original material as Open Game Content, You represent that Your Contributions are Your original creation and/or You have sufficient rights to grant the rights conveyed by this License.

6. Notice of License Copyright: You must update the COPYRIGHT NOTICE portion of this License to include the exact text of the COPYRIGHT NOTICE of any Open Game Content You are copying, modifying or distributing, and You must add the title, the copyright date, and the copyright holder's name to the COPYRIGHT NOTICE of any original Open Game Content you Distribute.

7. Use of Product Identity: You agree not to Use any Product Identity, including as an indication as to compatibility, except as expressly licensed in another, independent Agreement with the owner of each element of that Product Identity. You agree not to indicate compatibility or co-adaptability with any Trademark or Registered Trademark in conjunction with a work containing Open Game Content except as expressly licensed in another, independent Agreement with the owner of such Trademark or Registered Trademark. The use of any Product Identity in Open Game Content does not constitute a challenge to the ownership of that Product Identity. The owner of any Product Identity used in Open Game Content shall retain all rights, title and interest in and to that Product Identity.

8. Identification: If you distribute Open Game Content You must clearly indicate which portions of the work that you are distributing are Open Game Content.

9. Updating the License: Wizards or its designated Agents may publish updated versions of this License. You may use any authorized version of this License to copy, modify and distribute any Open Game Content originally distributed under any version of this License.

10. Copy of this License: You MUST include a copy of this License with every copy of the Open Game Content You distribute.

11. Use of Contributor Credits: You may not market or advertise the Open Game Content using the name of any Contributor unless You have written permission from the Contributor to do so.

12. Inability to Comply: If it is impossible for You to comply with any of the terms of this License with respect to some or all of the Open Game Content due to statute, judicial order, or governmental regulation then You may not Use any Open Game Material so affected.

13. Termination: This License will terminate automatically if You fail to comply with all terms herein and fail to cure such breach within 30 days of becoming aware of the breach. All sublicenses shall survive the termination of this License.

14. Reformation: If any provision of this License is held to be unenforceable, such provision shall be reformed only to the extent necessary to make it enforceable.

15. COPYRIGHT NOTICE

Open Game License v 1.0a © 2000, Wizards of the Coast, Inc.

System Reference Document © 2000, Wizards of the Coast, Inc.; Authors: Jonathan Tweet, Monte Cook, and Skip Williams, based on material by E. Gary Gygax and Dave Arneson.

Starfinder Core Rulebook © 2017, Paizo Inc.; Authors: Logan Bonner, Jason Bulmahn, Amanda Hamon Kunz, Jason Keeley, Robert G. McCreary, Stephen Radney-MacFarland, Mark Seifter, Owen K.C. Stephens, and James L. Sutter, with Alexander Augunas, Judy Bauer, John Compton, Adam Daigle, Crystal Frasier, Lissa Guillett, Thurston Hillman, Erik Mona, Mark Moreland, Jessica Price, F. Wesley Schneider, Amber E. Scott, and Josh Vogt.

Starfinder Tech Terrain Pawn Collection © 2019, Paizo Inc.; Author: Robert G. McCreary.

STARFINDER

PAWN COLLECTION

TECH TERRAIN

Bring the fixtures and fittings of the future to your tabletop with this collection of more than 100 terrain pawns for use with the Starfinder Roleplaying Game or any tabletop science fantasy RPG! Printed on sturdy cardstock, each double-sided pawn contains beautiful full-color images of the kinds of terrain and features that you would find in a space station, a gritty futuristic city, or on an alien planet. Each pawn lays flat or slots into a size-appropriate plastic base from the *Starfinder Pawns Base Assortment*, making them easy to mix with traditional metal or plastic miniatures and terrain. With multiple pawns for common objects and furnishings, the *Tech Terrain Pawn Collection* is the best way to ensure you've got the perfect set dressing for every Starfinder Roleplaying Game encounter!

Dozens of vividly illustrated pawns help you customize your campaign's space stations and alien planets. The *Tech Terrain Pawn Collection* includes:

1"-BY-1" PAWNS

Alien Bones (2)
Alien Eggs (2)
Alien Fungus (4)
Alien Plants (4)
Barrel (4)
Barricade (2)
Blood Spatter (4)
Briefcase (2)
Cable Line (2)
Cafe Table (4)
Chair (4)
Chair, Starship (6)
Computer Console, Small (4)
Conveyor Belt, Curved (4)
Corrosive Haze (2)
Crate (4)
Dead Alien (2)
Dead Body (2)
Fire (4)
Floor Hatch (2)
Fluid Spill/Oil Slick (4)
Glowing Crystal (2)
Grate (4)
Hydrant (2)
Ice (4)
Lava (4)

Machinery, Small (4)
Manhole (4)
Mines (2)
Mud (4)
Potted Plant (4)
Rubble (4)
Rune (2)
Security Camera (3)
Sentry Gun (3)
Shrub (4)
Skeleton, Humanoid (2)
Skeleton, Alien (2)
Smoke/Fog (4)
Space Suit (4)
Telescope, Small (2)
Trash Can (4)
Tree Stump (4)
Vent (4)

1"-BY-2" PAWNS

Arcane Laboratory
Baggage Car (2)
Baggage Truck
Bar (2)
Barbed Wire (4)
Bench (2)
Bunk (6)

Catwalk (4)
Chain Link Fence (4)
Computer Console, Large (2)
Concrete Barrier (4)
Conference Table
Conveyor Belt (6)
Couch (2)
Crate, Large (4)
Desk (2)
Door, Plastic (2)
Door, Steel (2)
Door, Stone (2)
Emergency Raft
Exposed Pipes (2)
Exposed Wiring (2)
Garbage Bin (2)
Hatch (2)
Machinery (2)
Medical Table (2)
Robot Training Dummy (2)
Science Lab
Shop Counter (2)
Stasis Pod (2)
Statue (2)
Statue, Holo (2)
Synthesis Bay
Tech Workshop

Telescope, Large
Toilet Cubicle (2)
Tree Trunk (4)
Vending Machine (2)
Video Game (2)
Wall of Fire (2)
Wall of Force (2)
Wall of Steel (2)
Weapon Rack (2)

2"-BY-2" PAWNS

Airlock
Airlock Door (2)
Comm Unit
Crater (2)
Double Door (2)
Fountain
Grease
Junk Pile (4)
Machinery, Large (2)
Power Core
Satellite Dish
Sculpture
Shipping Crate (2)
Tent, Mass-Produced (2)
Tent, Mobile Hotelier



This product does not include bases. It is intended for use with the bases found in the *Starfinder Pawns Base Assortment* or any Starfinder Pawns or Pathfinder Pawns bases.

paizo.com

PZ07412

© 2019, Paizo, Paizo Inc., the Paizo golem logo, Starfinder, and the Starfinder logo are registered trademarks of Paizo Inc.; Starfinder Pawns and Starfinder Roleplaying Game are trademarks of Paizo Inc. Made in China.

Paizo Inc., 7120 185th Ave NE, Suite 120, Redmond, WA 98052

In Europe: Ulisses Medien & Spiel Distribution GmbH, Industriestr. 11, 65529 Waldems/Steinfischbach, Deutschland

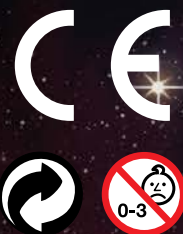

WARNING:
Not suitable for children
under three years